

Mesa Table, 60" x 216"

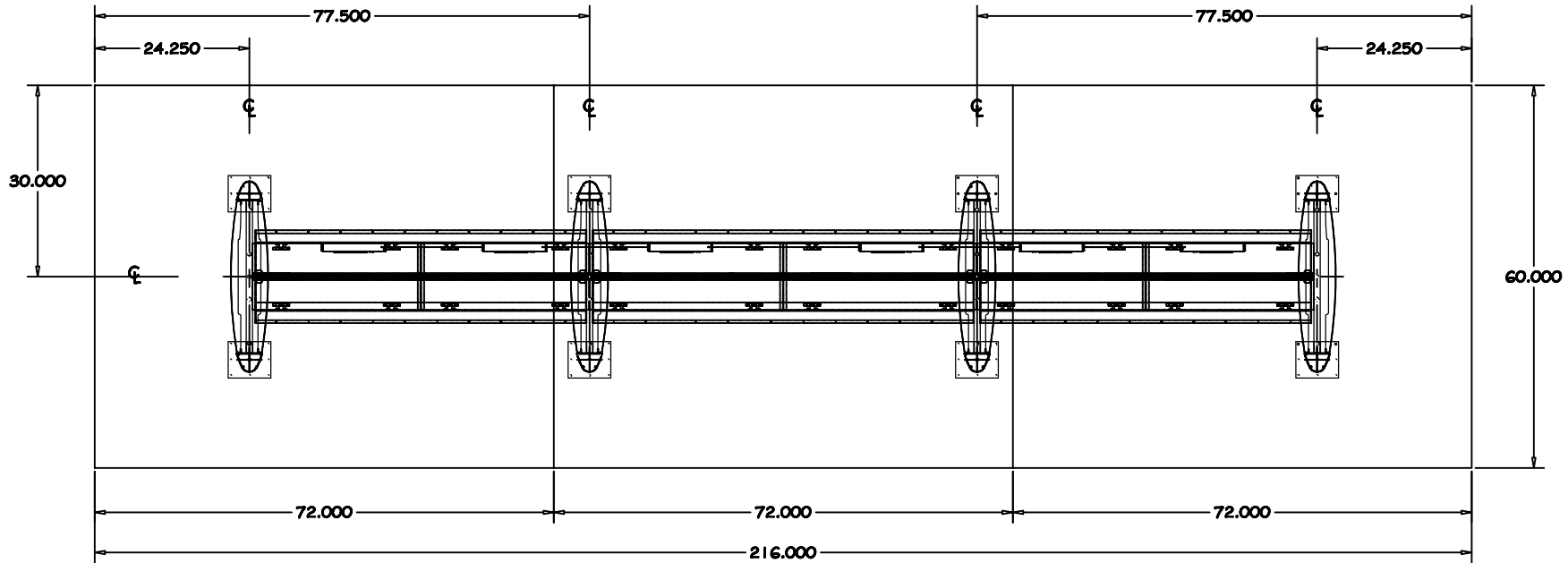

CLIENT:

Friant &
Associates

PROPOSAL #:

00000

NOTICE:

THIS DRAWING IS THE PROPERTY OF FRIANT & ASSOCIATES, LLC AND CONTAINS INFORMATION THAT IS NOT TO BE USED EXCEPT IN CONSIDERATION OF BIDS AND PROPOSALS TENDERED THEREWITH. REPRODUCTIONS OR COPYING OF THIS DRAWING, IN WHOLE OR IN PART, IS PROHIBITED.



4901 E. 12TH STREET
OAKLAND, CA 94601
TEL: (510) 535-5113

REVISIONS

DATE	BY:

SCALE: NTS
DATE: 8/17/10
DRAWN BY: G. Walker

SHEET NAME

Mesa Table
60 x 216 x 29H
Floor Core Locations
SHEET 1 of 1